

English

86PO

IMPORTANT SAFETY RULES

**Read, understand, and follow all
instructions carefully before
installing and using this product.**

Easy Set® Pool

8' - 18' (244 cm - 549 cm) models



For illustrative purposes only. Accessories may not be provided with pool.

Don't forget to try these other fine Intex products: pools, pool accessories, inflatable pools and in-home toys, airbeds and boats available at fine retailers or visit our website.

INTEX®

IMPORTANT! DO NOT RETURN PRODUCT TO STORE

**To purchase parts and accessories or to obtain non-technical assistance,
Visit www.intexcorp.com**

For technical assistance and missing parts call us toll-free (for U.S. and Canadian Residents):

1-800-234-6839

Monday through Friday, 8:30am to 5:00pm Pacific Time

086PO-R0-1006

OWNER'S MANUAL

Warnings..... 3

Parts List & Reference..... 4-5

SetUp Instructions..... 6-8

Pool Maintenance and Chemicals..... 9-10

Common Pool Problems..... 9

Pool Draining..... 10

Storage..... 10-11

General Aquatic Safety..... 12

Pool Safety Sign..... 13

Intex Service Center Locations..... 14

Special Introductory note:

Thanks for buying an Intex pool. Please take a few minutes to read this manual before setting up your pool. This information will help extend the pool life and make the pool safer for your family's enjoyment. We also recommend watching the instructional video on our website under www.intexcorp.com. The DVD version of the instructional video may be included with some pools, otherwise a free copy can be obtained by contacting one of the Intex service centers listed at the back of the manual. A team of 2 people is recommended for pool set up. Additional people will speed up the installation.

IMPORTANT SAFETY RULES

Read, Understand and Follow All Instructions Carefully Before Installing and Using this Product.

WARNING

- **Continuous and competent adult supervision of children and the handicapped is required at all times.**
- Secure all doors, windows and safety barriers to prevent unauthorized, unintentional or unsupervised pool entry.
- Install a safety barrier that will eliminate access to the pool for young children and pets.
- Pool and pool accessories are to be assembled and disassembled by adults only.
- Never dive, jump or slide into an above-ground pool or any shallow body of water.
- Failure to set up pool on flat, level, compact ground could result in the pool's collapse or the possibility that a person lounging in the pool could be swept out.
- Do not lean, straddle, or exert pressure on the inflatable ring or top rim as injury or flooding could occur. Do not allow anyone to sit on, climb, or straddle the sides of the pool.
- Remove all toys and flotation devices from, in and around the pool when it is not in use. Objects in the pool attract young children.
- Keep toys, chairs, tables, or any objects that a child could climb on at least four feet away from the pool.
- Keep rescue equipment by the pool and clearly post emergency numbers at the phone closest to the pool. Examples of rescue equipment: coast guard approved ring buoy with attached rope, strong rigid pole not less than twelve feet (12') [365.76cm] long.
- Never swim alone or allow others to swim alone.
- Keep your pool clean and clear. The pool floor must be visible at all times from the outside barrier of the pool.
- If swimming at night use artificial lighting to illuminate all safety signs, ladders, pool floor and walkways.
- Stay away from the pool when using alcohol or drugs.
- Keep children away from pool covers to avoid entanglement, drowning, or other serious injury.
- Pool covers must be completely removed **before** pool use. Children and adults cannot be seen under a pool cover.
- Do not cover the pool while you or anyone else is in the pool.
- Keep the pool and pool area clean and clear to avoid slips and falls and objects that may cause injury.
- Protect all pool occupants from recreational water illnesses by keeping the pool water clean. Don't swallow the pool water. Practice good hygiene.
- All pools are subject to wear and deterioration. Certain types of excessive or accelerated deterioration can lead to an operation failure. And can ultimately cause the loss of large quantities of water from your pool. So, therefore it is very important that you properly maintain your pool on a regular basis.
- This pool is for outdoor use only.
- Empty and store the pool when not in use for a longer period.
- All electrical components shall be installed in accordance with Article 680 of the National Electrical Code 1999 (NEC®) "Swimming Pools, Fountains and Similar Installations" or its latest approved edition.
- The installer of the vinyl liner shall affix on the original or replacement liner, or on the pool structure, all safety signs in accordance with the manufacturer's instructions. The safety signs shall be placed above the water line.

POOL BARRIERS AND COVERS ARE NOT SUBSTITUTES FOR CONTINUOUS AND COMPETENT ADULT SUPERVISION.





FAILURE TO FOLLOW THESE WARNINGS MAY RESULT IN PROPERTY DAMAGE, SERIOUS INJURY OR DEATH.

Advisory:

Pool owners may need to comply with local or state laws relating to childproof fencing, safety barriers, lighting, and other safety requirements. Customers should contact their local building code enforcement office for further details.

SAFETY RULES

PARTS LIST

<p>1</p> 	<p>2</p> 	<p>3</p>  <p>* Optional</p>
<p>4</p> 	<p>5</p> 	

NOTE: Drawings for illustration purpose only. May not reflect actual product. Not to scale.

PARTS REFERENCE

Before assembling your product, please take a a few minutes to check the contents and become familiar with all the parts.

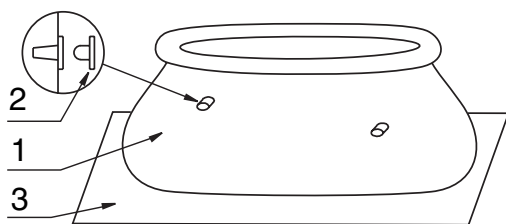

16' (488 cm) & below Easy Set® pools

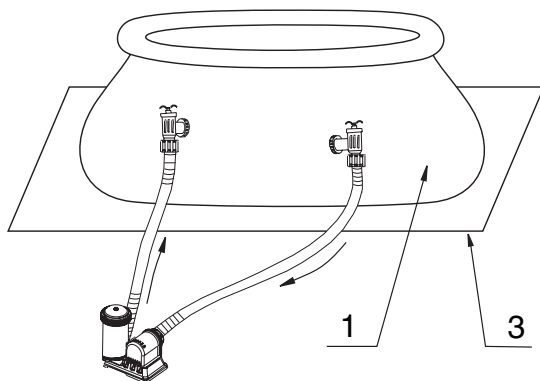

17' (518 cm) & above Easy Set® pools

PARTS LIST & REFERENCE

REF NO.	DESCRIPTION	POOL SIZE & QUANTITY						
		8' (244cm)	10' (305cm)	12' (366cm)	15' (457cm)	16' (488cm)	18' (549cm)	
1	POOL LINER (DRAIN VALVE CAP INCLUDED)	1	1	1	1	1	1	
2	STRAINER HOLE PLUG (WITH 1 EXTRA)	3	3	3	3	3	3	
3	GROUND CLOTH (OPTIONAL)	1	1	1	1	1	1	
4	DRAIN CONNECTOR	1	1	1	1	1	1	
5	DRAIN VALVE CAP	1	1	1	1	1	2	

REF NO.	DESCRIPTION	SPARE PART NO.									
		8' X 30" (244cm X 76cm)	10' X 30" (305cm X 76cm)	12' X 30" (366cm X 76cm)	12' X 33" (366cm X 84cm)	12' X 36" (366cm X 91cm)	15' X 33" (457cm X 84cm)	15' X 36" (457cm X 91cm)			
1	POOL LINER (DRAIN VALVE CAP INCLUDED)	10433	10318	10200	11155	10319	10622	10183			
2	STRAINER HOLE PLUG (WITH 1 EXTRA)	10127	10127	10127	10127	10127	10127	10127			
3	GROUND CLOTH (OPTIONAL)							18932			
4	DRAIN CONNECTOR	10184	10184	10184	10184	10184	10184	10184			
5	DRAIN VALVE CAP	10649	10649	10649	10649	10649	10649	10649			

REF NO.	DESCRIPTION	SPARE PART NO.									
		15' X 42" (457cm X 107cm)	15' X 48" (457cm X 122cm)	16' X 42" (488cm X 107cm)	16' X 48" (488cm X 122cm)	18' X 42" (549cm X 107cm)	18' X 48" (549cm X 122cm)	18' X 52" (549cm X 132cm)			
1	POOL LINER (DRAIN VALVE CAP INCLUDED)	10222	10415	10436	10623	10242	10320	10765			
2	STRAINER HOLE PLUG (WITH 1 EXTRA)	10127	10127	10127	10127						
3	GROUND CLOTH (OPTIONAL)	18932	18932	18927	18927	18933	18933	18933			
4	DRAIN CONNECTOR	10184	10184	10184	10184	10184	10184	10184			
5	DRAIN VALVE CAP	11044	11044	11044	11044	11044	11044	11044			

PARTS REFERENCE

POOL SETUP

IMPORTANT SITE SELECTION AND GROUND PREPARATION INFORMATION

WARNING

- The pool location must allow you to secure all doors, windows, and safety barriers to prevent unauthorized, unintentional or unsupervised pool entry.
- Install a safety barrier that will eliminate access to the pool for young children and pets.
- Failure to set up the pool on flat, level, compact ground and in accord with the following instructions could result in the pool's collapse or the possibility that a person lounging in the pool could be swept out, resulting in serious injury or property damage.
- Risk of electric shock: connect the filter pump only to a grounding type receptacle protected by a ground-fault circuit interrupter (GFCI). To reduce the risk of an electrical shock, do not use extension cords, timers, plug adapters or converter plugs to connect the pump to an electrical supply. Always provide a properly located outlet. Locate the cord where it cannot be damaged by lawn mowers, hedge trimmers, and other equipment. See the filter pump manual for additional warnings and instructions.

Select an outdoor location for the pool with the following in mind:

1. The area where the pool is to be set up must be **absolutely flat and level**.
Do not set up the pool on a slope or inclined surface.
2. The ground surface must be compacted and firm enough to withstand the pressure and weight of a fully set up pool. **Do not** set up the pool on mud, sand, soft or loose soil conditions.
3. **Do not** set up the pool on a deck or platform.
4. The pool requires at least 4 feet of space all around pool from objects that a child could climb on to gain access to the pool.
5. The chlorinated poolwater could damage the surrounding vegetation. Certain types of grass such as St. Augustine and Bermuda, may grow through the liner.

POOL SETUP (continued)

You may have purchased this pool with the Intex Krystal Clear™ filter pump. The pump has its own separate set of installation instructions. First assemble your pool unit and then set up the filter pump.

- Find a flat, level location that is free and clear of stones, branches or other sharp objects that may puncture the pool liner or cause injury.
 - Open the carton containing the liner, etc., very carefully as this carton can be used to store the pool during the winter months.

- Take out the ground cloth (3) and spread it over the cleared area. Then take out the liner (1) and spread it out over the ground cloth, with the drain valve directed towards the draining area. Place the drain valve away from the house.

IMPORTANT: Always set up the pool unit with at least 2 persons. Do not drag the liner across the ground as this can cause leaks or other damages (see drawing 2).

- During the setup of the pool liner, point the hose connections or openings in the direction of the electrical power source. The outer edge of the pool should be within reach of the pump's electrical connection.

- Lay out the pool. Spread out the plain blue sides and make the pool floor as smooth as possible (see drawing 2).

- Flip the top ring out and check that it is fully outside of the wall lining and facing up. Inflate the ring with a manual air pump (see drawing 3). Keep the top ring centered in the middle of the pool.

IMPORTANT: Prevent bursting by not using a high-pressure pump, such as an air compressor. Do not over inflate. Preferably use an Intex manual inflation hand pump (not included).

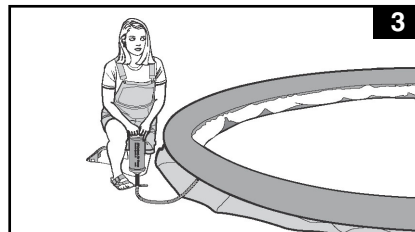
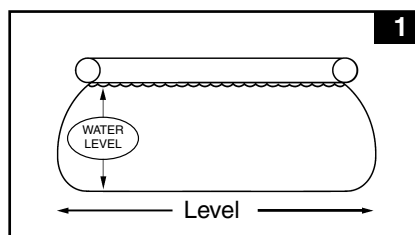

IMPORTANT

Proper inflation of the top ring.

The ambient temperatures of air and water have an effect on the internal pressure of the top ring. To maintain a correct internal pressure, it is best to leave some room for expansion as the sun heats the air inside the ring. During very hot weather, you must check to see whether it is necessary to release some air. This is to avoid any possible damage to the ring.

In no event shall Intex, their authorized agents or employees be liable for damages (such as pin holes) to the inflatable top ring caused by negligence, ordinary wear and tear, abuse and carelessness, or external forces.

- The following applies to pool liners with hose connectors (16" (488 cm) & below pools). If the pool was purchased **without** a filter pump, stick two black plugs (2) into the black filter pump outlets. Do this from the inside of the pool so that water will not run out when filling it. If the pool was purchased **with** a filter pump, consult the Krystal Clear™ Filter Pump Manual first and **then** go to step #5.

POOL SETUP (continued)

- 5. • Before filling the pool with water, ensure that the drain plug inside the pool is closed and that the drain cap on the outside is screwed on tightly. Fill the pool with no more than 1 inch of water. Check to see whether the water is level.

IMPORTANT: If the water in the pool flows to one side, the pool is not completely level. Setting up the pool on unlevelled ground will cause the pool to tilt resulting in the sidewall material to bulge. If the pool is not completely level, you must drain the pool, level the area and re-fill the pool.

- Smooth out the remaining wrinkles (from inside the pool) by pushing out where the pool floor and pool sides meet. Or, (from outside the pool) reach under the side of the pool, grasp the pool floor and pull it out. If the ground cloth is causing the trouble, have 2 adults pull from either side to remove all wrinkles (see drawing 4).

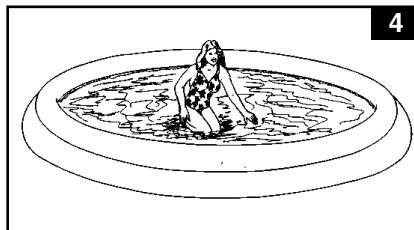

- 6. Now fill the pool with water. The pool liner walls will rise while you are filling it (see drawing 5).

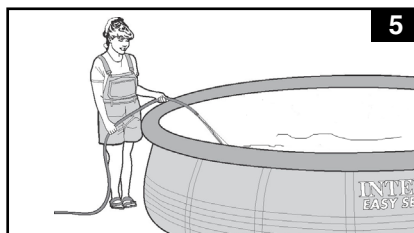

- 7. Fill the pool with water up to the bottom of the inflated ring (see drawings 1 and 6). For the 42" (107cm) wall height pools: fill the water just below the fill line printed on the inside of the inflated ring (see drawing 7).

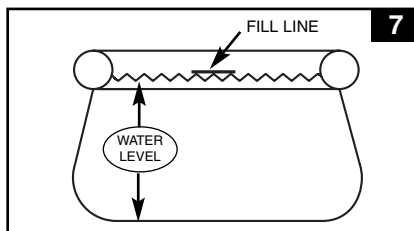
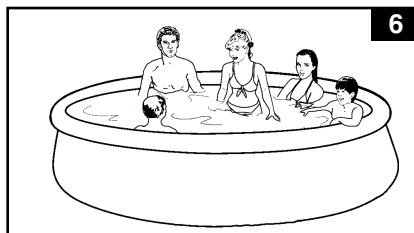

IMPORTANT

Before allowing anyone to use the pool, hold a family meeting. Establish a set of rules that include, at a minimum, the important safety rules and general aquatic safety information in this manual. Review these rules on a regular basis and with all users of the pool, including guests.

SETUP INSTRUCTIONS

POOL MAINTENANCE & CHEMICALS

⚠ WARNING

REMEMBER TO

- Protect all pool occupants from possible water-related illnesses by keeping the pool water clean. Do not swallow the pool water. Always practice good hygiene.
- Keep your pool clean and clear. The pool floor must be visible at all times from the outside barrier of the pool.
- Keep children away from pool covers to avoid entanglement, drowning, or other serious injury.

How to clean your top ring

To keep the top ring clean and free of stains, wipe the surface with a damp cloth after each use. Also cover the pool with a pool cover when not in use. If you have dark stains on the top ring surface, wipe it with a soft cloth using a solution of mild laundry detergent and water. Gently rub the stain and be careful not to let the dirt fall into the water. Do not use strong detergents, abrasive material or brushes.

The maintenance of a proper water balance is the single most important factor in maximizing the life and appearance of the liner as well as ensuring clean, healthy and safe water. Proper technique is important for water testing. See your pool professional for chemical, test kits and testing procedures. Be sure to read and follow the written instructions from the chemical manufacturer.

1. Never let chlorine come in contact with the liner if it is not completely dissolved. Dissolve granular or tablet chlorine first in a bucket of water, then add it to the pool water. Likewise with liquid chlorine; mix it immediately and thoroughly with the pool water.
2. Never mix chemicals together. Add the chemicals to the pool water separately. Thoroughly dissolve each chemical before adding another one to the water.
3. An Intex pool skimmer and an Intex pool vacuum are available to assist in maintaining clean pool water. See your pool dealer for these pool accessories.
4. Do not use a pressure washer to clean the pool.

TROUBLESHOOTING

PROBLEM	DESCRIPTION	CAUSE	SOLUTION
ALGAE	<ul style="list-style-type: none"> • Greenish water. • Green or black spots on pool liner. • Pool liner is slippery and/or has a bad odor. 	<ul style="list-style-type: none"> • Chlorine and pH level need adjustment. 	<ul style="list-style-type: none"> • Super chlorinate with shock treatment. Correct pH to your pool store's recommended level. • Vacuum pool bottom. • Maintain proper chlorine level.
COLORED WATER	<ul style="list-style-type: none"> • Water turns blue, brown, or black when first treated with chlorine. 	<ul style="list-style-type: none"> • Copper, iron or manganese in water being oxidized by the added chlorine. Common. 	<ul style="list-style-type: none"> • Adjust pH to recommended level. • Run filter until water is clear. • Replace cartridge frequently.
FLOATING MATTER IN WATER	<ul style="list-style-type: none"> • Water is cloudy or milky. 	<ul style="list-style-type: none"> • "Hard water" caused by a too high pH level. • Chlorine content is low. • Foreign matter in water. 	<ul style="list-style-type: none"> • Correct the pH level. Check with your pool dealer for advice. • Check for proper chlorine level. • Clean or replace your filter.
CHRONIC LOW WATER LEVEL	<ul style="list-style-type: none"> • Level is lower than on previous day. 	<ul style="list-style-type: none"> • Rip or hole in pool liner or hoses. 	<ul style="list-style-type: none"> • Repair with patch kit. • Finger tighten all caps. • Replace the hoses.
SEDIMENT ON POOL BOTTOM	<ul style="list-style-type: none"> • Dirt or sand on pool floor. 	<ul style="list-style-type: none"> • Heavy use, getting in and out of pool. 	<ul style="list-style-type: none"> • Use Intex pool vacuum to clean bottom of pool.
SURFACE DEBRIS	<ul style="list-style-type: none"> • Leaves, insects etc. 	<ul style="list-style-type: none"> • Pool too close to trees. 	<ul style="list-style-type: none"> • Use Intex pool skimmer.

MAINTENANCE

POOL MAINTENANCE & DRAINAGE



CAUTION

ALWAYS FOLLOW THE CHEMICAL MANUFACTURER'S DIRECTIONS, AND THE HEALTH AND HAZARD WARNINGS.

Do not add chemicals if the pool is occupied. This can cause skin or eye irritation. Concentrated chlorine solutions can damage the pool liner. In no event is Intex Recreation Corp., Intex Development Co. Ltd., their related companies, authorized agents and service centers, retailers or employees liable to the buyer or any other party for costs associated with the loss of pool water, chemicals or water damage. **Keep spare filter cartridges on hand. Replace cartridges every two weeks.** We recommend the use of a Krystal Clear™ Intex Filter Pump with all of our above-ground-pools. **To purchase an Intex Filter Pump or other accessories see your local retailer, visit our website or call the Intex Consumer Services Department at the number below and have your Visa or Mastercard ready.**

www.intexcorp.com

1-800-234-6839

Consumer Service 8:30 am to 5:00 pm PT (Mon.-Fri.)

EXCESSIVE RAIN: To avoid damage to the pool, immediately drain rain water that causes the water level to be higher than the maximum.

How to Drain Your Pool and Long Term Storage

1. Check local regulations for specific directions regarding disposal of swimming pool water.
2. Check to make sure that the drain plug inside the pool is plugged in place.
3. Remove the cap from the drain valve on the outside pool wall.
4. Attach the female end of the garden hose to the patented drain connector (3).
5. Place the other end of the hose in an area where the water can be safely drained away from the house.
6. Attach the drain connector (3) to the drain valve. **NOTE: The drain connector will push the drain plug open inside the pool and water will start to drain immediately.**
7. Disconnect hose and adapter when finished.
8. Re-insert drain plug in drain valve on inside of pool for storage.
9. Replace drain cap on outside of pool.
10. Completely deflate the top ring, and remove all plumbing parts.
11. Be sure that the pool and all parts are completely dry before folding. Let it lie in the sun for an hour (see drawing 8). Sprinkle some talcum powder to prevent the vinyl from sticking together and to absorb any moisture you may have missed.
12. Create a square shape. Starting at one side, fold one-sixth of liner in on itself twice. Do the same on the opposite side (see drawings 9.1 & 9.2).
13. Once you have created two opposing folded sides, simply fold one over the other like closing a book (see drawings 10.1 & 10.2).
14. Fold the two long ends to the middle (see drawing 11).
15. Fold one over the other like closing a book and finally compact the liner (see drawing 12).
16. Store the liner and accessories in a dry, temperature controlled, between 32 degrees Fahrenheit (0 degrees Celsius) and 104 degrees Fahrenheit (40 degrees Celsius), storage location.
17. The original packing can be used for storage.

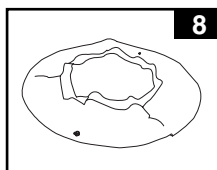

8

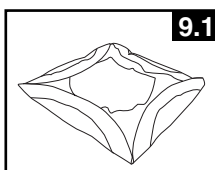

9.1

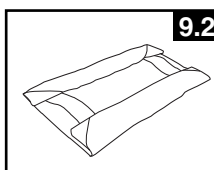

9.2

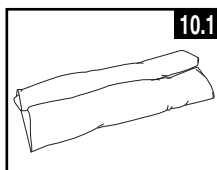

10.1

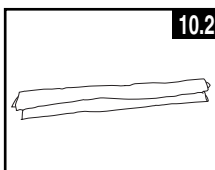

10.2

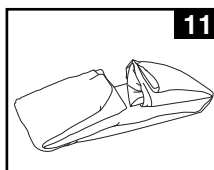

11

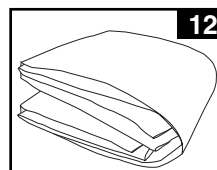

12

WINTER PREPARATIONS

Winterizing your Above Ground Pool

After usage, you can easily empty and store away your pool in a safe place. Some people however, choose to leave their pool up all year round. In cold areas, where freezing temperatures occur, there can be a risk of ice damage to your pool unit. We therefore recommend you to drain, disassemble and properly store away the unit, when the temperature drops below 32 degrees Fahrenheit (0 degrees Celsius). Also see the section "How To Drain Your Pool".

Should you choose to leave your pool out, prepare it as follows:

1. Clean the pool water thoroughly. If the type is an Easy Set Pool or an Oval Frame Pool, make sure that the top ring is properly inflated.
2. Remove the skimmer (if applicable) or any accessories attached to the threaded strainer connector. Replace strainer grid if necessary. Be sure all accessories parts are clean and completely dry before storage.
3. Plug the Inlet and Outlet fitting from the inside of the pool with the plug provided (sizes 16' and below). Close the Inlet and Outlet Plunger Valve (sizes 17' and above).
4. Remove the ladder (if applicable) and store in a safe place. Be sure the ladder is completely dry before storage.
5. Remove the hoses that connect the pump and filter to the pool.
6. Add the appropriate chemicals for the winter period. Consult your local pool dealer as to which chemicals you should use and how to use them. This can vary greatly per region.
7. Cover pool with Intex Pool Cover. **IMPORTANT NOTE: INTEX POOL COVER IS NOT A SAFETY COVER.**
8. Clean and drain the pump, filter housing and hoses. Remove and discard the old filter cartridge. Keep a spare cartridge for the next season.
9. Bring pump and filter parts indoors and store in a safe and dry area, preferably between 32 degrees Fahrenheit (0 degrees Celsius) and 104 degrees Fahrenheit (40 degrees Celsius).

STORAGE

GENERAL AQUATIC SAFETY

Water recreation is both fun and therapeutic. However, it involves inherent risks of injury and death. To reduce your risk of injury, read and follow all product, package and package insert warnings and instructions. Remember, however, that product warnings, instructions and safety guidelines cover some common risks of water recreation, but do not cover all instances or risk and or danger.

For additional safeguards, also familiarize yourself with the following general guidelines as well as guidelines provided by nationally recognized Safety Organizations:

- Demand constant supervision.
- Learn to swim.
- Take the time to learn CPR and first aid.
- Instruct anyone who is watching your children about potential pool hazards and about the use of protective devices such as locked doors, barriers, etc.
- Teach children what to do in case of an emergency.
- Always use common sense and good judgement when enjoying any water activity.
- Supervise, supervise, supervise.

For additional information on safety, please visit

- The Association of Pool and Spa Professionals: The Sensible Way to Enjoy Your Aboveground/Onground Swimming Pool www.nspi.org
- American Academy of Pediatrics: Pool Safety for Children www.aap.org
- Red Cross www.redcross.org
- Safe Kids www.safekids.org
- Home Safety Council: Safety Guide www.homesafetycouncil.org
- Toy Industry Association: Toy Safety www.toy-tia.org

SAFETY IN YOUR POOL

Safe swimming depends on constant attention to the rules. The "NO DIVING" sign within this manual can be posted near your pool to help keep everyone alert to the danger. You may also wish to copy and laminate the sign for protection from the elements.

POST THIS WARNING NEAR YOUR POOL

! WARNING

**NO DIVING OR JUMPING
SHALLOW WATER**

DIVING MAY RESULT IN PERMANENT INJURY OR DEATH

- Be Safe. Swim with a friend.
- Children must be accompanied by an adult.
- Don't swim when using alcohol or drugs.
- Be familiar with the pool before swimming.
- No running, jumping, or horseplay in or around pool.
- No glass in pool area.



TO AVOID SERIOUS INJURY ALL POOL USERS MUST KNOW AND FOLLOW THESE SAFETY RULES.

SAVE THESE INSTRUCTIONS

COUNTRIES/REGIONS**SERVICE CENTER LOCATIONS**

- UNITED STATES
- CANADA

INTEX RECREATION CORP.
 14779 Bar Harbor Road
 Fontana, CA 92336
 Tel: 1-800-234-6839
 Fax: 310-549-2900
 Website: www.intexcorp.com (U.S./Canada only)
 Consumer Service Hours: 8:30 am to 5:00 pm
 Pacific Time, Mon. thru Fri. only.

- MEXICO

KAY INTERNACIONAL, S.A. DE C.V.
 Avenida San Jeronimo #550-5° Piso, Col.
 Jardines del Pedregal, C.P. 01900
 México D.F.
 Tel: 01-800-347-4020 (Collect Call)
 Tel: 55-9172-8035
 Fax: 55-9172-8047
 E-mail: servicenter@kayinternacional.com
 Website: www.intexmexico.com.mx

- PANAMA
- PARAGUAY
- ECUADOR
- HONDURAS
- EL SALVADOR
- NICARAGUA

**SUPRO MUNDIAL S.A./
 PRODUCTOS SUPERIORES S.A.**
 Boulevard Andrews, Albrook,
 Panama, Rep. of Panama
 Tel: 507-300-3800
 Fax: 507-300-3813
 E-mail: suproadmin@supropanama.com

- COSTA RICA
- DOMINICAN REPUBLIC
- GUATEMALA
- COLOMBIA
- VENEZUELA

CENTURY USA, LLC
 4731 W. Atlantic Ave., Suite B-3
 Delray Beach, FL 33445, USA
 Tel: 561-495-0648
 Fax: 561-495-4782
 E-mail: sales@centuryusa.com

- MIDDLE EAST REGION

FIRST GROUP INTERNATIONAL
 Al Moosa Group Building, 1st Floor,
 Office 102 & 103, UMM Hurair Road,
 Karama, Dubai, UAE
 Tel: 00971-4-3373322
 Fax: 00971-4-3375115
 E-mail: info@firstgroupinternational.com
 Website: www.firstgroupinternational.com

- ASIA

INTEX DEVELOPMENT CO. LTD.
 8th Floor,
 Dah Sing Financial Centre
 108 Gloucester Road,
 Wanchai, Hong Kong
 Tel: 852-28270000
 Fax: 852-23118200
 E-mail: xmservicesupport@intexcorp.com.cn
 Website: www.intexdevelopment.com

For answers to most frequently asked questions, please visit www.intexcorp.com.
 Non U.S. Residents, please visit www.intexdevelopment.com.

English

®
INTEX

For Residents of the U.S. & Canada:

INTEX RECREATION CORP.

Attn: Consumer Service

14779 Bar Harbor Road

Fontana, CA 92336

Phone: 1-800-234-6839

Fax: (310) 549-2900

Consumer Service Hours:

8:30 am to 5:00 pm Pacific time

Monday thru Friday only

Website: www.intexcorp.com

For Residents outside of the U.S. and Canada:

Please refer to the Service Center Locations

©2009 Intex Marketing Ltd. - Intex Development Co. Ltd. -
Intex Trading Ltd. - Intex Recreation Corp.

All rights reserved/Tous droits réservés/Todos los
derechos reservados/Alle Rechte vorbehalten.

Printed in China/Imprimé en Chine/Impreso en
China/Gedruckt in China.

®™ Trademarks used in some countries of the world under
license from/®™ Marques utilisées dans certains pays sous
licence de/Marcas registradas utilizadas en algunos países
del mundo bajo licencia de/Warenzeichen verwendet in
einigen Ländern der Welt in Lizenz von/Intex Marketing Ltd.
to/à/a/an Intex Trading Ltd., Intex Development Co. Ltd.,
G.P.O Box 28829, Hong Kong & Intex Recreation Corp.,
P.O. Box 1440, Long Beach, CA 90801 • Distributed in the
European Union by/Distribué dans l'Union Européenne
par/Distribuido en la Unión Europea por/Vertrieb in der
Europäischen Union durch/Intex Trading B.V., P.O. Box nr.
1075 - 4700 BB Roosendaal - The Netherlands

 **INTEX®**